



**Single swivel**

Threads M8 – M48  
Loads 0,3 tons  
to 15 tons



**Double swivel**

Threads M4 – M100  
Loads 0,05 tons  
to 50 tons

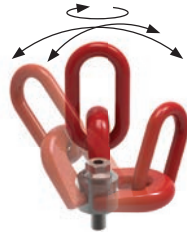

**Triple swivel**

Threads M8 – M56  
Loads 0,3 tons  
to 22 tons

### Introduction to swivel lifting rings and Lifting Bolts (P4002-P4055)

Our swivel lifting rings fully comply with the EC directive 2006/42/EC. They are CE marked and are supplied with a Certificate of Conformity. There is a 100% check on anti-cracking, a proof load test of 2.5 x load limit and a safety factor of 5 on most parts. Each ring is individually marked to ensure full product traceability.

The Swivel Lifting Rings come in three main forms – depending on the number of axis required to swivel. The most popular type is the double swivel rings.

### Other Standard Lifting Bolts

#### Standard lifting bolts (to DIN 580 and DIN 582) (P4040-P4048)

These are CE marked and are available with male or female threads in either steel or stainless steel (A4 AISI 316). They are meant only for linear loading of the bolts at a maximum angle of 45° from the thread. They are not meant for loads that might swivel.

These are supplied with a generic CE Certificate of Conformity stating that the parts have been manufactured to the relevant DIN standard and therefore suitable for lifting.

#### High-tensile lifting bolts (P4054-P4055)

The High-tensile lifting bolts are similar to the standard lifting bolts but are rated at higher loads and can lift loads at up to 90° from the thread. They are not meant for loads that might swivel.

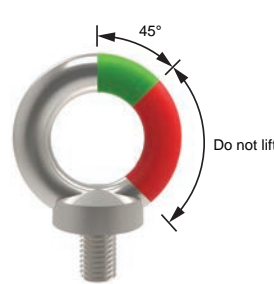

**Standard lifting bolts**  
DIN 580 & DIN 582  
P4040-P4048



**Hi-tensile lifting bolts**  
P4054-P4055

### Swivel lifting rings operating instructions.

**Please follow these instructions carefully.**

- Ensure all lifting bolts are CE marked.
- Ensure they are handled by qualified personnel.
- Refer to the operating instructions particularly with regards to product selection, any possibility of the load swivelling, the effect of lifting angles on the load capacity (see relevant tables), etc.
- Never allow any personnel underneath a suspended load.
- Always heed the load rating of the lifting bolt.
- Always perform a visual inspection of the lifting rings prior to use. Checking for any damage to thread and/or swivelling system. Check for wear or corrosion, signs of stress or bending. Check CE mark and load rating.
- Ensure a yearly full service inspection is performed.
- Always ensure the full bottom face of the lifting bolts is in contact with a smooth, square surface.
- Ensure bolt is tightened to the correct torque.
- Ensure full and unrestricted movement of the lifting ring in all directions.
- Before each lift ensure the correct orientation of the shackle in the lift direction.
- Avoid using our standard steel lifting rings in corrosive environments eg sandy, chemical, acid, moisture etc. In this case consider using our stainless steel lifting rings.

- Note the thread length requirements:
  - 1 x thread diameter for steel (ST37 min.).
  - 1.25 x thread diameter for cast iron.
  - 2 x thread diameter for aluminium.
  - 2.5 x thread diameter for other light metals.
  - If fixing into low resistance material it is better to allow for a bigger diameter thread to compensate for the lower material resistance.

Note: The full thread must be engaged. Longer thread lengths can be supplied on request or a bolt and washer/nut combination can be used.



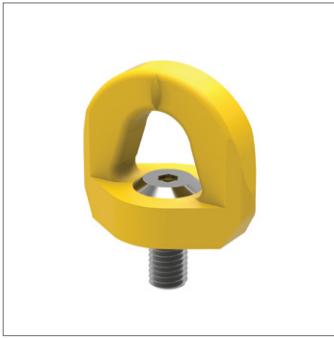

**P4030**

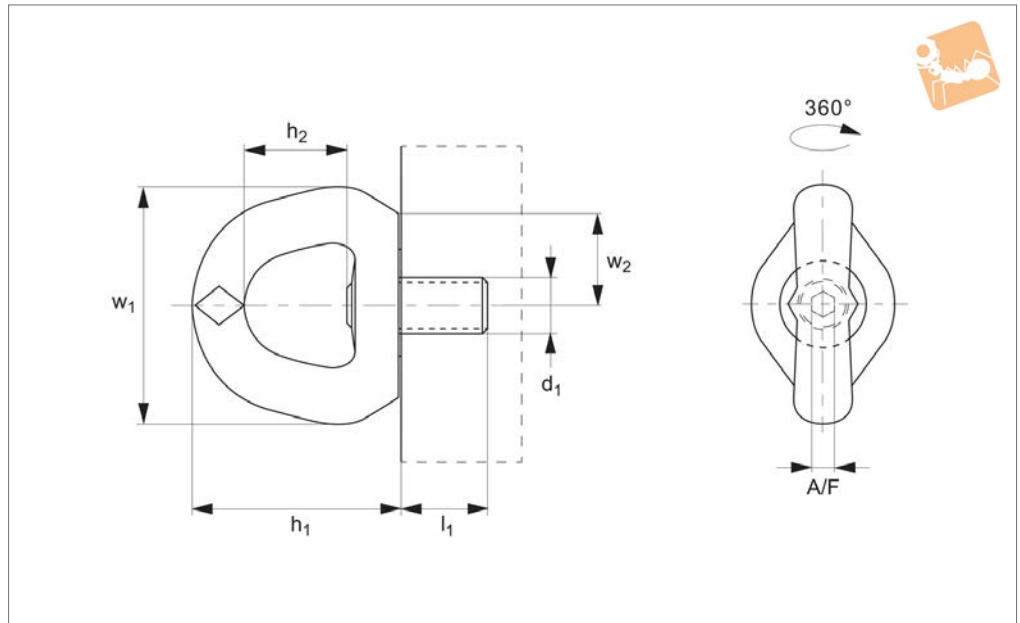

**Material**

High tensile corrosion resistant steel, strength class >8.  
Coloured yellow to indicate personnel safety.  
Supplied with CE certificate.

**Technical Notes**

Conforms to EN795:2012.  
Single articulation, 360°.  
Clearly marked with maximum number of persons. The yellow colour indicates the personnel safety use.

**Tips**

Marked with the number of persons the ring is certified to support.  
For use by personnel wearing safety harnesses. Suitable for 1 or 2 persons as marked.  
Typically used in building maintenance, wind power and offshore industries.

**Important Notes**

The thread diameter and depth must be appropriate to the material into which it will be installed:

Steel (min. ST37) - 1 x thread dia.  
Cast iron - 1.25 x thread dia.  
Aluminium - 2 x thread dia.  
Other light metals - 2.5 x thread dia.  
Tolerance of female thread to be 6H (metric).

**Please refer to the safety documentation before using this part.  
Supplied with certificate and operating instructions.**

Order No.	No. of persons max.	$l_1$	$w_1$	$h_1$	$d_1$ tol. 6g	$h_2$	$w_2$	$w_3$	A/F	Torque to Nm	Weight kg
P4030.M012	1	21	60	57	M12x1,75	30	20	34	6	15	0.24
P4030.M016	1	27	88	80	M16x2,00	38	35	45	8	50	0.80
P4030.M020	1	30	88	80	M20x2,50	38	35	45	8	100	0.80



# Product Overview

## Swivel Lifting Rings

# Lifting Bolts



### Temperature extremes

- 40°C to -20°C Load rating reduces by 20%.
- +200°C to +300°C Load rating reduces by 10%.
- +300°C to +400°C Load rating reduces by 25%.

### Rugged

For harsh environments we recommend the use of our stainless steel lifting rings.

### Product marking

Compliant with 2006/42/EC, and with individual date of manufacture and batch number.

Complies with 2006/42/CE

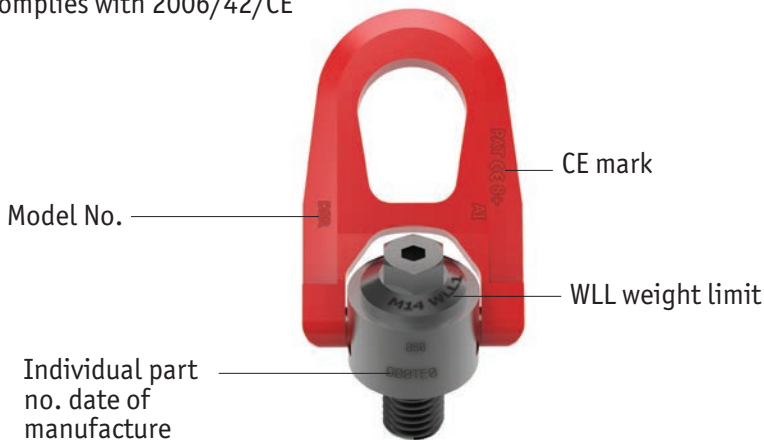

### P4020

Threads M8 – M30  
Loads 0,3 tons to 3 tons.



### P4022

Threads M30 – M45  
Loads 3,5 tons to 6 tons.



### Installation Information

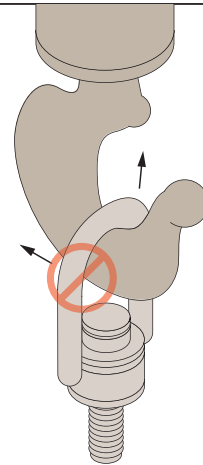

**Never** use an oversized hook or other lifting device which will pry or tend to open the "U" shaped bar on center pull hoist rings.

### Lifting angles

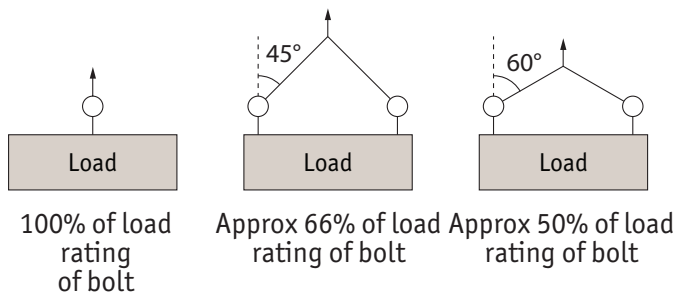

For full information on lifting arrangements see technical pages

### Steel and Stainless steel (316) versions



Steel



Stainless (316L)

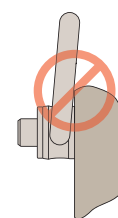

After installation, check the hoist ring to be sure it swivels and pivots freely in all directions. **The side of the ring must not contact anything.**

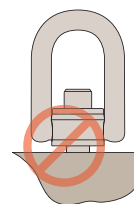

**Always** ensure full thread engagement when installing hoist rings. Also ensure face is flush.

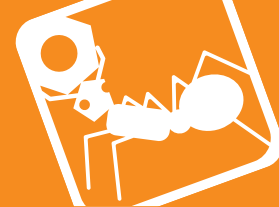

P4002 Male



P4004 Female



Lifting type									$\alpha \text{ max.} = 60^\circ$ 		$\alpha \text{ max.} = 60^\circ$ 	
	No. of rings	1	2	1	2	2	2	4	4			
Lifting angle	0°	0°	90°	90°	45°	60°	45°	60°				
Part no.	Thread											
P4002.M008 & P4004.M008	M 8	0,30 tons	0,60 tons	0,30 tons	0,60 tons	0,40 tons	0,30 tons	0,60 tons	0,30 tons			
P4002.M010 & P4004.M010	M10	0,60 tons	1,20 tons	0,60 tons	1,20 tons	0,80 tons	0,60 tons	1,30 tons	0,60 tons			
P4002.M012 & P4004.M012	M12	1,00 tons	2,00 tons	1,00 tons	2,00 tons	1,40 tons	1,00 tons	2,10 tons	1,00 tons			
P4002.M016 & P4004.M016	M16	1,60 tons	3,20 tons	1,60 tons	3,20 tons	2,20 tons	1,60 tons	3,40 tons	1,60 tons			
P4002.M020 & P4004.M020	M20	2,50 tons	5,00 tons	2,50 tons	5,00 tons	3,50 tons	2,50 tons	5,30 tons	2,50 tons			
P4002.M024 & P4004.M024	M24	4,00 tons	8,00 tons	4,00 tons	8,00 tons	5,60 tons	4,00 tons	8,40 tons	4,00 tons			
P4002.M030 & P4004.M030	M30	6,30 tons	12,60 tons	6,30 tons	12,60 tons	8,80 tons	6,30 tons	13,20 tons	6,30 tons			
P4002.M036 & P4004.M036	M36	10,00 tons	20,00 tons	10,00 tons	20,00 tons	14,00 tons	10,00 tons	21,00 tons	10,00 tons			
P4002.M042	M42	12,50 tons	25,00 tons	12,50 tons	25,00 tons	17,50 tons	12,50 tons	26,30 tons	12,50 tons			
P4002.M048	M48	15,00 tons	30,00 tons	15,00 tons	30,00 tons	21,00 tons	15,00 tons	31,50 tons	15,00 tons			

LIFTING PINS, LIFTING BOLTS & SWING BOLTS

ov-W63020-AP4002-T-W63024-AP4004-T lifting-bolts-single-lifting-rings-lmh-Updated - 19-01-2023

# Technical Information

## Double Swivel Lifting Rings

# Lifting Bolts

P4005 Male



P4006 Female



Lifting type									$\alpha$ max. = 60° 		$\alpha$ max. = 60° 	
	1	2	1	2	2	2	4	4				
No. of rings	1	2	1	2	2	2	4	4				
Lifting angle	0°	0°	90°	90°	45°	60°	45°	60°				
Part no.	Thread											
P4005.M004	M 4	0,050 tons	0,100 tons	0,050 tons	0,100 tons	0,070 tons	0,050 tons	0,100 tons	0,050 tons			
P4005.M005	M 5	0,075 tons	0,150 tons	0,075 tons	0,150 tons	0,100 tons	0,075 tons	0,150 tons	0,075 tons			
P4005.M006	M 6	0,100 tons	0,200 tons	0,100 tons	0,200 tons	0,140 tons	0,100 tons	0,200 tons	0,100 tons			
P4005.M008 & P4006.M008	M 8	0,30 tons	0,60 tons	0,30 tons	0,60 tons	0,40 tons	0,30 tons	0,60 tons	0,30 tons			
P4005.M010 & P4006.M010	M10	0,60 tons	1,20 tons	0,60 tons	1,20 tons	0,80 tons	0,60 tons	1,30 tons	0,60 tons			
P4005.M012 & P4006.M012	M12	1,00 tons	2,00 tons	1,00 tons	2,00 tons	1,40 tons	1,00 tons	2,10 tons	1,00 tons			
P4005.M014 & P4006.M014	M14	1,30 tons	2,60 tons	1,30 tons	2,60 tons	1,80 tons	1,30 tons	2,70 tons	1,30 tons			
P4005.M016 & P4006.M016	M16	1,60 tons	3,20 tons	1,60 tons	3,20 tons	2,20 tons	1,60 tons	3,40 tons	1,60 tons			
P4005.M018 & P4006.M018	M18	2,00 tons	4,00 tons	2,00 tons	4,00 tons	2,80 tons	2,00 tons	4,20 tons	2,00 tons			
P4005.M020 & P4006.M020	M20	2,50 tons	5,00 tons	2,50 tons	5,00 tons	3,50 tons	2,50 tons	5,30 tons	2,50 tons			
P4005.M022 & P4006.M022	M22	3,00 tons	6,00 tons	3,00 tons	6,00 tons	4,20 tons	3,00 tons	6,30 tons	3,00 tons			
P4005.M024	M24	4,00 tons	8,00 tons	4,00 tons	8,00 tons	5,60 tons	4,00 tons	8,40 tons	4,00 tons			
P4005.M027	M27	5,00 tons	10,00 tons	5,00 tons	10,00 tons	7,00 tons	5,00 tons	10,50 tons	5,00 tons			
P4005.M030	M30	6,30 tons	12,60 tons	6,30 tons	12,60 tons	8,8 tons	6,30 tons	13,20 tons	6,30 tons			
P4005.I031 & P4006.I031	(UNC 5/16"-18)	650 lbs	1,300 lbs	650 lbs	1,300 lbs	910 lbs	650 lbs	1,365 lbs	650 lbs			
P4005.I037 & P4006.I037	(UNC 3/8"-16)	1,200 lbs	2,400 lbs	1,200 lbs	2,400 lbs	1,680 lbs	1,200 lbs	2,520 lbs	1,200 lbs			
P4005.I050 & P4006.I050	(UNC 1/2"-13)	2,200 lbs	4,400 lbs	2,200 lbs	4,400 lbs	3,080 lbs	2,200 lbs	4,620 lbs	2,200 lbs			
P4005.I063 & P4006.I063	(UNC 5/8"-11)	3,800 lbs	7,600 lbs	3,800 lbs	7,600 lbs	5,320 lbs	3,800 lbs	7,980 lbs	3,800 lbs			
P4005.I075 & P4006.I075	(UNC 3/4"-10)	5,500 lbs	11,000 lbs	5,500 lbs	11,000 lbs	7,700 lbs	5,500 lbs	11,550 lbs	5,500 lbs			
P4005.I088 & P4006.I088	(UNC 7/8"-9)	6,600 lbs	13,200 lbs	6,600 lbs	13,200 lbs	9,240 lbs	6,600 lbs	13,860 lbs	6,600 lbs			
P4005.I100	(UNC 1"-8)	10,000 lbs	20,000 lbs	10,000 lbs	20,000 lbs	14,000 lbs	10,000 lbs	21,000 lbs	10,000 lbs			

ov-W63050-AP4005-T-W63054-AP4006-T-lifting-bolts-double-lifting-rings-rmh - Updated 19.01.2023

LIFTING PINS, LIFTING BOLTS & SWING BOLTS



P4020 Male



P4021 Female



Lifting type									$\alpha \text{ max.} = 60^\circ$ 		$\alpha \text{ max.} = 60^\circ$ 	
	1	2	1	2	2	2	4	4				
No. of rings	1	2	1	2	2	2	4	4				
Lifting angle	0°	0°	90°	90°	45°	60°	45°	60°				
Part no.	Thread											
P4020.M008 & P4021.M008	M 8		0,30 tons	0,60 tons	0,30 tons	0,60 tons	0,40 tons	0,30 tons	0,60 tons	0,30 tons		
P4020.M009	M 8		0,30 tons	0,60 tons	0,30 tons	0,60 tons	0,40 tons	0,30 tons	0,60 tons	0,30 tons		
P4020.M010 & P4021.M008	M10		0,50 tons	1,00 tons	0,50 tons	1,00 tons	0,70 tons	0,50 tons	1,10 tons	0,50 tons		
P4020.M011	M10		0,50 tons	1,00 tons	0,50 tons	1,00 tons	0,70 tons	0,50 tons	1,10 tons	0,50 tons		
P4020.M012 & P4021.M008	M12		0,80 tons	1,60 tons	0,80 tons	1,60 tons	1,10 tons	0,80 tons	1,70 tons	0,80 tons		
P4020.M013	M12		0,80 tons	1,60 tons	0,80 tons	1,60 tons	1,10 tons	0,80 tons	1,70 tons	0,80 tons		
P4020.M014 & P4021.M008	M14		1,00 tons	2,00 tons	1,00 tons	2,00 tons	1,40 tons	1,00 tons	2,10 tons	1,00 tons		
P4020.M016 & P4021.M008	M16		1,50 tons	3,00 tons	1,50 tons	3,00 tons	2,10 tons	1,50 tons	3,20 tons	1,50 tons		
P4020.M018 & P4021.M008	M18		1,50 tons	3,00 tons	1,50 tons	3,00 tons	2,10 tons	1,50 tons	3,20 tons	1,50 tons		
P4020.M020 & P4021.M008	M20		1,60 tons	3,20 tons	1,60 tons	3,20 tons	2,20 tons	1,60 tons	3,40 tons	1,60 tons		
P4020.M022 & P4021.M008	M22		2,00 tons	4,00 tons	2,00 tons	4,00 tons	2,80 tons	2,00 tons	4,20 tons	2,00 tons		
P4020.M024	M24		2,70 tons	5,40 tons	2,70 tons	5,40 tons	3,80 tons	2,70 tons	5,70 tons	2,70 tons		
P4020.M027	M27		2,80 tons	5,60 tons	2,80 tons	5,60 tons	3,90 tons	2,80 tons	5,90 tons	2,80 tons		
P4020.M030	M30		3,00 tons	6,00 tons	3,00 tons	6,00 tons	4,20 tons	3,00 tons	6,30 tons	3,00 tons		



# Technical Information

## Heavy Duty Double Swivel Lifting Rings



P4008 Male

P4010 Female



Lifting type									$\alpha$ max. = 60° 		$\alpha$ max. = 60° 	
	No. of rings	1	2	1	2	2	2	4	4			
Lifting angle	0°		0°		90°		90°		45°		60°	
Part no.	Thread											
P4008.M024 & P4010.M024	M24	4,50 tons	9,00 tons	4,50 tons	9,00 tons	6,30 tons	4,50 tons	9,50 tons	4,50 tons			
P4010.M027	M27	5,00 tons	10,00 tons	5,00 tons	10,00 tons	7,00 tons	5,00 tons	10,50 tons	5,00 tons			
P4008.M030 & P4010.M030	M30	7,30 tons	14,60 tons	7,30 tons	14,60 tons	10,20 tons	7,30 tons	15,30 tons	7,30 tons			
P4008.M033 & P4010.M033	M33	8,00 tons	16,00 tons	8,00 tons	16,00 tons	11,20 tons	8,00 tons	16,80 tons	8,00 tons			
P4008.M036 & P4010.M036	M36	10,00 tons	20,00 tons	10,00 tons	20,00 tons	14,00 tons	10,00 tons	21,00 tons	10,00 tons			
P4008.M037	M36	10,00 tons	20,00 tons	10,00 tons	20,00 tons	14,00 tons	10,00 tons	21,00 tons	10,00 tons			
P4008.M039 & P4010.M039	M39	10,00 tons	20,00 tons	10,00 tons	20,00 tons	14,00 tons	10,00 tons	21,00 tons	10,00 tons			
P4008.M042 & P4010.M042	M42	12,50 tons	25,00 tons	12,50 tons	25,00 tons	17,50 tons	12,50 tons	26,30 tons	12,50 tons			
P4008.M043	M42	12,50 tons	25,00 tons	12,50 tons	25,00 tons	17,50 tons	12,50 tons	26,30 tons	12,50 tons			
P4008.M045 & P4010.M045	M45	15,00 tons	30,00 tons	15,00 tons	30,00 tons	21,00 tons	15,00 tons	31,50 tons	15,00 tons			
P4008.M048 & P4010.M048	M48	20,00 tons	40,00 tons	20,00 tons	40,00 tons	28,00 tons	20,00 tons	42,00 tons	20,00 tons			
P4008.M049	M48	20,00 tons	40,00 tons	20,00 tons	40,00 tons	28,00 tons	20,00 tons	42,00 tons	20,00 tons			
P4008.M050	M50	20,00 tons	40,00 tons	20,00 tons	40,00 tons	28,00 tons	20,00 tons	42,00 tons	20,00 tons			
P4008.M052 & P4010.M052	M52	20,00 tons	40,00 tons	20,00 tons	40,00 tons	28,00 tons	20,00 tons	42,00 tons	20,00 tons			
P4008.M056	M56	25,00 tons	50,00 tons	25,00 tons	50,00 tons	35,00 tons	25,00 tons	52,50 tons	25,00 tons			
P4008.M057	M56	25,00 tons	50,00 tons	25,00 tons	50,00 tons	35,00 tons	25,00 tons	52,50 tons	25,00 tons			
P4008.M064	M64	32,10 tons	64,20 tons	32,10 tons	64,20 tons	44,90 tons	32,10 tons	67,40 tons	32,10 tons			
P4008.M065	M65	32,10 tons	64,20 tons	32,10 tons	64,20 tons	44,90 tons	32,10 tons	67,40 tons	32,10 tons			
P4008.M072	M72	25,00 tons	50,00 tons	25,00 tons	50,00 tons	35,00 tons	25,00 tons	52,50 tons	25,00 tons			
P4008.M073	M72	25,00 tons	50,00 tons	25,00 tons	50,00 tons	35,00 tons	25,00 tons	52,50 tons	25,00 tons			
P4008.M080	M80	32,10 tons	64,20 tons	32,10 tons	64,20 tons	44,90 tons	32,10 tons	67,40 tons	32,10 tons			
P4008.M090	M90	32,10 tons	64,20 tons	32,10 tons	64,20 tons	44,90 tons	32,10 tons	67,40 tons	32,10 tons			
P4008.M100	M100	32,10 tons	64,20 tons	32,10 tons	64,20 tons	44,90 tons	32,10 tons	67,40 tons	32,10 tons			
P4010.I100	(UNC 1"-8)	10,000 lbs	20,000 lbs	10,000 lbs	20,000 lbs	14,000 lbs	10,000 lbs	21,000 lbs	10,000 lbs			
P4008.I125 & P4010.I125	(UNC 1 1/4"-7)	14,000 lbs	28,000 lbs	14,000 lbs	28,000 lbs	19,600 lbs	14,000 lbs	29,400 lbs	14,000 lbs			
P4008.I137 & P4010.I137	(UNC 1 3/8"-6*)	20,000 lbs	40,000 lbs	20,000 lbs	40,000 lbs	28,000 lbs	20,000 lbs	42,000 lbs	20,000 lbs			
P4008.I150 & P4010.I150	(UNC 1 1/2"-6)	20,000 lbs	40,000 lbs	20,000 lbs	40,000 lbs	28,000 lbs	20,000 lbs	42,000 lbs	20,000 lbs			
P4008.I200 & P4010.I200	(UNC 2"-4 1/2)	50,000 lbs	100,000 lbs	50,000 lbs	100,000 lbs	70,000 lbs	50,000 lbs	105,000 lbs	50,000 lbs			

ov-W63080.1-AP4008-T-W63084-AP4010-T-lifting-bolts-heavy-duty-double-lifting-rings-rmh- Updated 19.01.2023

LIFTING PINS, LIFTING BOLTS & SWING BOLTS



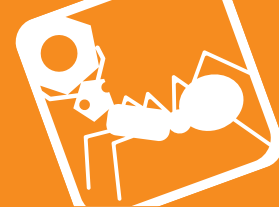

P4011 Male



Lifting type									$\alpha$ max. = 60°		$\alpha$ max. = 60°	
	No. of rings	1	2	1	2	2	2	4	4			
Lifting angle	0°	0°	90°	90°	45°	60°	45°	60°				
Part no.	Thread											
P4011.M064	M64	33,00 tons	66,00 tons	33,00 tons	66,00 tons	46,00 tons	33,00 tons	69,00 tons	33,00 tons			
P4011.M072	M72	35,00 tons	70,00 tons	35,00 tons	70,00 tons	49,00 tons	35,00 tons	74,00 tons	35,00 tons			
P4011.M073	M72	35,00 tons	70,00 tons	35,00 tons	70,00 tons	49,00 tons	35,00 tons	74,00 tons	35,00 tons			
P4011.M080	M80	40,00 tons	80,00 tons	40,00 tons	80,00 tons	56,00 tons	40,00 tons	84,00 tons	40,00 tons			
P4011.M090	M90	45,00 tons	90,00 tons	45,00 tons	90,00 tons	63,00 tons	45,00 tons	95,00 tons	45,00 tons			
P4011.M100	M100	50,00 tons	100,00 tons	50,00 tons	100,00 tons	70,00 tons	50,00 tons	105,00 tons	50,00 tons			
P4011.I225	(UNC 2"1/4-4)	55,000 lbs	110,000 lbs	55,000 lbs	110,000 lbs	77,000 lbs	55,000 lbs	115,500 lbs	55,000 lbs			
P4011.I250	(UNC 2"1/2-4)	70,000 lbs	140,000 lbs	70,000 lbs	140,000 lbs	98,000 lbs	70,000 lbs	147,000 lbs	70,000 lbs			
P4011.I275	(UNC 2"3/4-4)	75,000 lbs	150,000 lbs	75,000 lbs	150,000 lbs	105,000 lbs	75,000 lbs	157,500 lbs	75,000 lbs			
P4011.I300	(UNC 3"-4)	80,000 lbs	160,000 lbs	80,000 lbs	160,000 lbs	112,000 lbs	80,000 lbs	168,000 lbs	80,000 lbs			
P4011.I325	(UNC 3"1/4-4)	90,000 lbs	180,000 lbs	90,000 lbs	180,000 lbs	126,000 lbs	90,000 lbs	189,000 lbs	90,000 lbs			
P4011.I350	(UNC 3"1/2-4)	95,000 lbs	190,000 lbs	95,000 lbs	190,000 lbs	133,000 lbs	95,000 lbs	199,500 lbs	95,000 lbs			
P4011.I375	(UNC 3"3/4-4)	100,000 lbs	200,000 lbs	100,000 lbs	200,000 lbs	140,000 lbs	100,000 lbs	210,000 lbs	100,000 lbs			
P4011.I400	(UNC 4"-4)	110,000 lbs	220,000 lbs	110,000 lbs	220,000 lbs	154,000 lbs	110,000 lbs	231,000 lbs	110,000 lbs			



# Technical Information

## Heavy Duty Stainless Steel Double Swivel Lifting Rings

# Lifting Bolts

P4022 Male

P4023 Female



Lifting type									$\alpha$ max. = 60° 		$\alpha$ max. = 60° 	
	1	2	1	2	2	2	4	4				
No. of rings	1	2	1	2	2	2	4	4				
Lifting angle	0°	0°	90°	90°	45°	60°	45°	60°				
Part no.	Thread											
P4023.M024	M24	2,70 tons	5,40 tons	2,70 tons	5,40 tons	3,80 tons	2,70 tons	5,70 tons	2,70 tons			
P4023.M027	M27	2,80 tons	5,60 tons	2,80 tons	5,60 tons	3,90 tons	2,80 tons	5,90 tons	2,80 tons			
P4022.M030 & P4023.M30	M30	3,50 tons	7,00 tons	3,50 tons	7,00 tons	4,90 tons	3,50 tons	7,30 tons	3,50 tons			
P4022.M033 & P4023.M33	M33	3,50 tons	7,00 tons	3,50 tons	7,00 tons	4,90 tons	3,50 tons	7,30 tons	3,50 tons			
P4022.M036 & P4023.M36	M36	5,00 tons	10,00 tons	5,00 tons	10,00 tons	7,00 tons	5,00 tons	10,50 tons	5,00 tons			
P4022.M037	M36	5,00 tons	10,00 tons	5,00 tons	10,00 tons	7,00 tons	5,00 tons	10,50 tons	5,00 tons			
P4022.M039	M39	5,00 tons	10,00 tons	5,00 tons	10,00 tons	7,00 tons	5,00 tons	10,50 tons	5,00 tons			
P4022.M042	M42	6,00 tons	12,00 tons	6,00 tons	12,00 tons	8,40 tons	6,00 tons	12,60 tons	6,00 tons			
P4022.M043	M42	6,00 tons	12,00 tons	6,00 tons	12,00 tons	8,40 tons	6,00 tons	12,60 tons	6,00 tons			
P4022.M045	M45	6,00 tons	12,00 tons	6,00 tons	12,00 tons	8,40 tons	6,00 tons	12,60 tons	6,00 tons			
P4022.I100 & P4023.I100	(UNC 1"-8)	6,000 lbs	12,000 lbs	6,000 lbs	12,000 lbs	8,400 lbs	6,000 lbs	12,600 lbs	6,000 lbs			
P4022.I125 & P4023.I125	(UNC 1 1/4"-7)	7,500 lbs	15,000 lbs	7,500 lbs	15,000 lbs	10,500 lbs	7,500 lbs	15,750 lbs	7,500 lbs			
P4022.I137 & P4023.I137	(UNC 1 3/8"-6)	7,500 lbs	15,000 lbs	7,500 lbs	15,000 lbs	10,500 lbs	7,500 lbs	15,750 lbs	7,500 lbs			
P4022.I150	(UNC 1 1/2"-6)	11,000 lbs	22,000 lbs	11,000 lbs	22,000 lbs	15,400 lbs	11,000 lbs	23,100 lbs	11,000 lbs			

ov-W63210-AP4022-T-W63214-AP4023-T-lifting-bolts-stainless-heavy-duty-double-ring-rmh- Updated 19.01.2023

LIFTING PINS, LIFTING BOLTS & SWING BOLTS



P4012 Male



Lifting type	0°		90°		α max. = 60°		α max. = 60°		
	1	2	1	2	2	2	4	4	
No. of rings	1	2	1	2	2	2	4	4	
Lifting angle	0°	0°	90°	90°	45°	60°	45°	60°	
Part no.	Thread								
P4012.M008	M 8	0,30 tons	0,60 tons	0,30 tons	0,60 tons	0,40 tons	0,30 tons	0,60 tons	0,30 tons
P4012.M010	M10	0,60 tons	1,20 tons	0,60 tons	1,20 tons	0,80 tons	0,60 tons	1,30 tons	0,60 tons
P4012.M012	M12	1,00 tons	2,00 tons	1,00 tons	2,00 tons	1,40 tons	1,00 tons	2,10 tons	1,00 tons
P4012.M014	M14	1,30 tons	2,60 tons	1,30 tons	2,60 tons	1,80 tons	1,30 tons	2,70 tons	1,30 tons
P4012.M016	M16	1,60 tons	3,20 tons	1,60 tons	3,20 tons	2,20 tons	1,60 tons	3,40 tons	1,60 tons
P4012.M018	M18	2,00 tons	4,00 tons	2,00 tons	4,00 tons	2,80 tons	2,00 tons	4,20 tons	2,00 tons
P4012.M020	M20	2,50 tons	5,00 tons	2,50 tons	5,00 tons	3,50 tons	2,50 tons	5,30 tons	2,50 tons
P4012.I031	(UNC 5/16"-18)	650 lbs	1,300 lbs	650 lbs	1,300 lbs	910 lbs	650 lbs	1,365 lbs	650 lbs
P4012.I037	(UNC 3/8"-16)	1,200 lbs	2,400 lbs	1,200 lbs	2,400 lbs	1,680 lbs	1,200 lbs	2,520 lbs	1,200 lbs
P4012.I050	(UNC 1/2"-13)	2,200 lbs	4,400 lbs	2,200 lbs	4,400 lbs	3,080 lbs	2,200 lbs	4,620 lbs	2,200 lbs
P4012.I063	(UNC 5/8"-11)	3,800 lbs	7,600 lbs	3,800 lbs	7,600 lbs	5,320 lbs	3,800 lbs	7,980 lbs	3,800 lbs
P4012.I075	(UNC 3/4"-10)	5,500 lbs	11,000 lbs	5,500 lbs	11,000 lbs	7,700 lbs	5,500 lbs	11,550 lbs	5,500 lbs

LIFTING PINS, LIFTING BOLTS & SWING BOLTS



# Technical Information

## Hook Double Swivel Lifting Rings

# Lifting Bolts

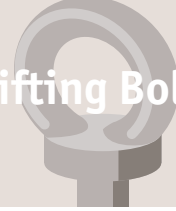

P4017 Male



Lifting type	0°		90°		α max. = 60°		α max. = 60°		
	1	2	1	2	2	2	4	4	
No. of rings	1	2	1	2	2	2	4	4	
Lifting angle	0°	0°	90°	90°	45°	60°	45°	60°	
Part no.	Thread								
P4017.M008	M 8	0,30 tons	0,60 tons	0,30 tons	0,60 tons	0,40 tons	0,30 tons	0,60 tons	0,30 tons
P4017.M010	M10	0,60 tons	1,20 tons	0,60 tons	1,20 tons	0,80 tons	0,60 tons	1,30 tons	0,60 tons
P4017.M012	M12	1,00 tons	2,00 tons	1,00 tons	2,00 tons	1,40 tons	1,00 tons	2,10 tons	1,00 tons
P4017.M014	M14	1,30 tons	2,60 tons	1,30 tons	2,60 tons	1,80 tons	1,30 tons	2,70 tons	1,30 tons
P4017.M016	M16	1,60 tons	3,20 tons	1,60 tons	3,20 tons	2,20 tons	1,60 tons	3,40 tons	1,60 tons
P4017.M018	M18	2,00 tons	4,00 tons	2,00 tons	4,00 tons	2,80 tons	2,00 tons	4,20 tons	2,00 tons
P4017.M020	M20	2,50 tons	5,00 tons	2,50 tons	5,00 tons	3,50 tons	2,50 tons	5,30 tons	2,50 tons
P4017.I031	(UNC 5/16"-18)	650 lbs	1,300 lbs	650 lbs	1,300 lbs	910 lbs	650 lbs	1,365 lbs	650 lbs
P4017.I038	(UNC 3/8"-16)	1,200 lbs	2,400 lbs	1,200 lbs	2,400 lbs	1,680 lbs	1,200 lbs	2,520 lbs	1,200 lbs
P4017.I050	(UNC 1/2"-13)	2,200 lbs	4,400 lbs	2,200 lbs	4,400 lbs	3,080 lbs	2,200 lbs	4,620 lbs	2,200 lbs
P4017.I063	(UNC 5/8"-11)	3,800 lbs	7,600 lbs	3,800 lbs	7,600 lbs	5,320 lbs	3,800 lbs	7,980 lbs	3,800 lbs
P4017.I075	(UNC 3/4"-10)	5,500 lbs	11,000 lbs	5,500 lbs	11,000 lbs	7,700 lbs	5,500 lbs	11,550 lbs	5,500 lbs



P4015 Male



Lifting type									$\alpha$ max. = 60° 		$\alpha$ max. = 60° 	
	1	2	1	2	2	2	4	4				
No. of rings	1	2	1	2	2	2	4	4				
Lifting angle	0°	0°	90°	90°	45°	60°	45°	60°				
Part no.	Thread											
P4015.M008	M 8	0,30 tons	0,60 tons	0,30 tons	0,60 tons	0,40 tons	0,30 tons	0,60 tons	0,30 tons			
P4015.M010	M10	0,60 tons	1,20 tons	0,60 tons	1,20 tons	0,80 tons	0,60 tons	1,30 tons	0,60 tons			
P4015.M012	M12	1,00 tons	2,00 tons	1,00 tons	2,00 tons	1,40 tons	1,00 tons	2,10 tons	1,00 tons			
P4015.M014	M14	1,30 tons	2,60 tons	1,30 tons	2,60 tons	1,80 tons	1,30 tons	2,70 tons	1,30 tons			
P4015.M016	M16	1,60 tons	3,20 tons	1,60 tons	3,20 tons	2,20 tons	1,60 tons	3,40 tons	1,60 tons			
P4015.M018	M18	2,00 tons	4,00 tons	2,00 tons	4,00 tons	2,80 tons	2,00 tons	4,20 tons	2,00 tons			
P4015.M020	M20	2,50 tons	5,00 tons	2,50 tons	5,00 tons	3,50 tons	2,50 tons	5,30 tons	2,50 tons			
P4015.M022	M22	3,00 tons	6,00 tons	3,00 tons	6,00 tons	4,20 tons	3,00 tons	6,30 tons	3,00 tons			
P4015.M024	M24	4,00 tons	8,00 tons	4,00 tons	8,00 tons	5,60 tons	4,00 tons	8,40 tons	4,00 tons			
P4015.M027	M27	5,00 tons	10,00 tons	5,00 tons	10,00 tons	7,0 tons	5,00 tons	10,50 tons	5,00 tons			
P4015.M030	M30	6,30 tons	12,60 tons	6,30 tons	12,60 tons	8,80 tons	6,30 tons	13,20 tons	6,30 tons			
P4015.M036	M36	10,00 tons	20,00 tons	10,00 tons	20,00 tons	14,00 tons	10,00 tons	21,00 tons	10,00 tons			
P4015.M042	M42	12,50 tons	25,00 tons	12,50 tons	25,00 tons	17,50 tons	12,50 tons	26,30 tons	12,50 tons			
P4015.M048	M48	20,00 tons	40,00 tons	20,00 tons	40,00 tons	28,00 tons	20,00 tons	42,00 tons	20,00 tons			
P4015.M056	M56	22,00 tons	44,00 tons	22,00 tons	44,00 tons	30,80 tons	22,00 tons	46,20 tons	22,00 tons			
P4015.I031	(UNC 5/16"-18)	650 lbs	1,300 lbs	650 lbs	1,300 lbs	910 lbs	650 lbs	1,365 lbs	650 lbs			
P4015.I037	(UNC 3/8"-16)	1,200 lbs	2,400 lbs	1,200 lbs	2,400 lbs	1,680 lbs	1,200 lbs	2,520 lbs	1,200 lbs			
P4015.I050	(UNC 1/2"-13)	2,200 lbs	4,400 lbs	2,200 lbs	4,400 lbs	3,080 lbs	2,200 lbs	4,620 lbs	2,200 lbs			
P4015.I063	(UNC 5/8"-11)	3,800 lbs	7,600 lbs	3,800 lbs	7,600 lbs	5,320 lbs	3,800 lbs	7,980 lbs	3,800 lbs			
P4015.I075	(UNC 3/4"-10)	5,500 lbs	11,000 lbs	5,500 lbs	11,000 lbs	7,700 lbs	5,500 lbs	11,550 lbs	5,500 lbs			
P4015.I088	(UNC 7/8"-9)	6,600 lbs	13,200 lbs	6,600 lbs	13,200 lbs	9,240 lbs	6,600 lbs	13,860 lbs	6,600 lbs			
P4015.I100	(UNC 1"-8)	10,000 lbs	20,000 lbs	10,000 lbs	20,000 lbs	14,000 lbs	10,000 lbs	21,000 lbs	10,000 lbs			
P4015.I125	(UNC 1 1/4"-7)	14,000 lbs	28,000 lbs	14,000 lbs	28,000 lbs	19,600 lbs	14,000 lbs	29,400 lbs	14,000 lbs			
P4015.I150	(UNC 1 1/1"-6)	20,000 lbs	40,000 lbs	20,000 lbs	40,000 lbs	28,000 lbs	20,000 lbs	42,000 lbs	20,000 lbs			
P4015.I200	(UNC 2"-4 1/2)	50,000 lbs	100,000 lbs	50,000 lbs	100,000 lbs	70,000 lbs	50,000 lbs	105,000 lbs	50,000 lbs			